

pipa™ lite series



nuna®

Designed
around your life



**IMPORTANT!
KEEP THESE
INSTRUCTIONS FOR
FUTURE REFERENCE:
*READ CAREFULLY***

Contents

Product Information	
Product Registration	4
Recall Information	4
Warranty	5
Contact	5
Child Usage Requirements	5
Warnings	6
Vehicle Compatibility	9
Infant Car Seat Parts List	12
Base Parts List	14
Product Overview	16
Product Use	26
Installation	30
Accessories	44
PIPA series organic cotton insert	44
PIPA series adapters	44
Cleaning and Maintenance	46

Product Information

Model Number: _____

Manufactured in (date): _____

Product Registration

Please fill in the above information. The model number and the manufactured in date are located on a label on the bottom of your child restraint. Fill out the prepaid registration postcard attached to the seat pad and mail it today.

Child restraints could be recalled for safety reasons. You must register this restraint to be reached in a recall. Send your name, address, e-mail address if available and the Child Restraint's model number and manufacturing date to:

Nuna Baby Essentials Inc.
70 Thousand Oaks Blvd.
Morgantown, PA 19543

or call 1.855.NUNA.USA

or register online at:
www.nuna.eu/register-car-seat

Recall Information

For recall information, call the U.S. Government's Vehicle Safety Hotline at: 1.888.327.4236 (TTY: 1.800.424.9153) or go to <http://www.NHTSA.gov>

Warranty

We have purposely designed our high-quality products so that they can grow with both your child and your family. Because we stand by our product, our gear is covered by a custom warranty per product, starting from the day it was purchased. Please have the proof of purchase, model number and manufactured in date available when you contact us.

For warranty information please visit:
www.nuna.eu/warranty

Contact

For replacement parts, service, or additional warranty questions, please contact our customer service department.

In the USA:
infousa@nuna.eu
www.nuna.eu
1.855.NUNA.USA

Child Usage Requirements

PIPA lite and PIPA lite lx are suitable for use with children who meet the following requirements:

Weight: 4 to 32 lbs (2 to 14.5 kg)

Height: less than 32 inches (81 cm)

It is recommended to keep your child rear facing as long as possible, until at least 2 years old.

⚠️ WARNING

Failure to follow these warnings, instructions and labels on the child restraint could result in serious injury or death.

A child's safety is your responsibility. **NEVER** leave your child unattended.

Read all instructions before use of this child restraint or installation in a vehicle. In addition, read the vehicle owner's manual for information on child restraint installation.

Use the bottom of the base for storage of the instruction manual.

This child restraint can **ONLY** be used in a rear facing position when used in a vehicle and **MUST** be installed in a vehicle with the base. This child restraint cannot be properly secured in a forward facing position or without a base. Use only with children who weigh between 4 and 32 pounds (2 and 14.5 kg) and whose height is 32 inches (81 cm) or less. Exceeding these height and weight limits is unsafe.

Snugly adjust the belts provided with this child restraint around your child. If straps are not snugly adjusted, child may be ejected from seat in the event of an accident.

A snug strap should not allow any slack. It lies in a relatively straight line without sagging. It does not press on the child's flesh or push the child's body into an unnatural position.

Register your child restraint with the manufacturer.

Cover the child restraint when your vehicle is parked in sunlight. Parts of a child restraint can become very hot if left in the sun, and can burn a child's skin. Check for hot parts before putting your child in the child restraint.

Replace this child restraint if it has been involved in a crash, even if it was minor and there appears to be no damage to the child restraint.

EXPIRATION DATE Check the label on the underside of the base or child restraint for expiration date information.

FALL HAZARD Child's activity can move carrier. **NEVER** place carrier on counter tops, tables, or any other elevated surface. Always stay within arms reach whenever carrier is not on floor/ground. Be sure handle locks into position before lifting carrier.

STRANGULATION HAZARD Children have strangled in loose or partially buckled harness straps. Fully restrain the child even when carrier is used outside the vehicle.

SUFFOCATION HAZARD Infant carrier can roll over on soft surfaces and suffocate child. Never place carrier on beds, sofas, or other soft surfaces.

ALWAYS check child restraint to base connection.

DO NOT allow anyone who has not read the instruction manual to install or use this child restraint.

DO NOT allow child restraint or handle to contact the vehicle interior (side of car door or seat in front) when installed on base.

DO NOT use child restraint if it has frayed or cut harness straps, or is damaged in any way. To find out if damaged parts are replaceable, call 1-855-NUNA-USA.

DO NOT use any products or accessories with this child restraint unless they are approved by Nuna for use with this child restraint. Doing so may be unsafe and may void the warranty.

NEVER leave child restraint and base in vehicle when uninstalled, even when unoccupied. In a crash, it could become a projectile and injure other vehicle occupants.

NEVER modify any part of the child restraint.

NEVER use clothing or blankets that interfere with providing a properly tightened harness. An unsecured or improperly harnessed child can come out of the restraint during a crash. Place blankets over child **AFTER** harness has been properly tightened.

NEVER place carrier on top of a shopping cart. Carrier will not be properly secured and could fall.

Only use with Nuna strollers or appropriate Nuna adapters designed for use with other strollers.

Vehicle Compatibility

You **MUST** read and understand **ALL** child restraint related instructions and warnings in your vehicle owner's manual to correctly and safely use this child restraint in your vehicle.

This child restraint can **ONLY** be installed on vehicle seats that face forward and **MUST** be installed in a vehicle with the base. **DO NOT** install in seats that face to the sides or rear of the vehicle.

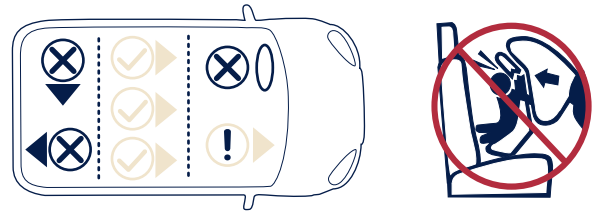

NEVER install this child restraint rear facing in a vehicle seating position with a frontal air bag unless it is turned off. Airbags inflate with great force and can cause severe injury to a child's neck and spine. If your vehicle is equipped with passenger side air bags, check your vehicle owner's manual for child restraint installation instructions.

According to accident statistics, children are safer when properly restrained in the rear seating positions than in the front seating positions.

Refer to your vehicle owner's manual to determine if the belts in your vehicle lock by switching the seat belt's retractor **OR** if they have a locking latch plate that locks the vehicle's seat belt so they will hold the child restraint tightly without loosening.

⚠ This child restraint **MUST** be installed in a vehicle with the base.

The following vehicle belts **CAN NOT BE USED** with your child restraint:

1 - Motorized Belts (Automatic)

These should not be used unless the shoulder belt can be removed, the lap belt is locked and use is allowed by the vehicle manufacturer.

2 - Dual Retractor Lap/Shoulder Belts

If allowed by the manufacturer, the lap belt only may be used to secure the child restraint in accordance with this manual and the vehicle's manual.

3 - Non-Locking (ELR) Lap Belts

This belt locks in a crash or sudden stop and should only be used with a belt shortening clip. Contact your vehicle manufacturer if needed.

4 - Airbag/Inflatable Belts

This belt can not be used to install this child restraint.

5 - Door Mounted Belts

This belt can not be used to install this child restraint.

6 - Lap Belts forward of Seat Bight

This belt (where the seat bottom and back meet) should not be used to install this child restraint.

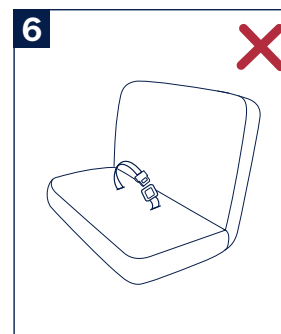
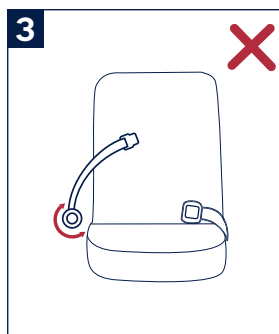
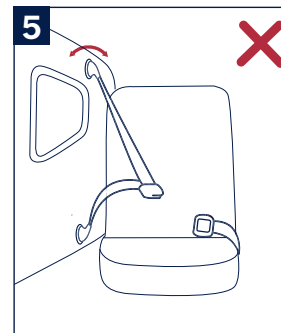
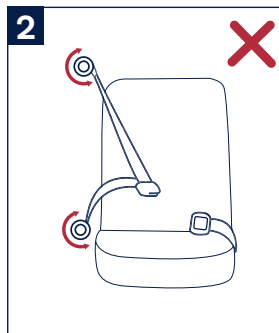
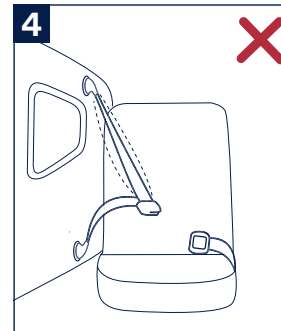
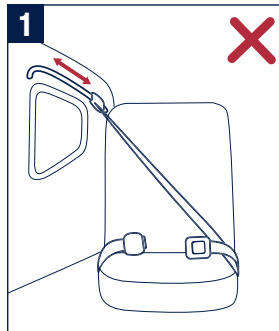

Infant Car Seat Parts List

Make sure all parts are available before assembly. If any part is missing, please contact Nuna (see page 4 for information). No tools are required for assembly.

- | | |
|-----------------------------|------------------------------|
| 1 Canopy | 12 Shoulder Harness Pads |
| 2 Seat Pad | 13 Head Support (x2) |
| 3 Body Support (x2) | 14 Handle |
| 4 Chest Clip | 15 Stroller Release Button** |
| 5 Buckle and Crotch Pad | 16 Harness Slots |
| 6 Harness Adjustment Button | 17 Base Attachment Bar |
| 7 Harness Adjustment Strap | 18 Harness Straps |
| 8 Buckle Holder | 19 Shoulder Harness Loops |
| 9 Handle Adjustment Button | 20 Splitter Plate |
| 10 Stroller Release Button* | 21 Base Attachment Bar |
| 11 Canopy Release Button | |

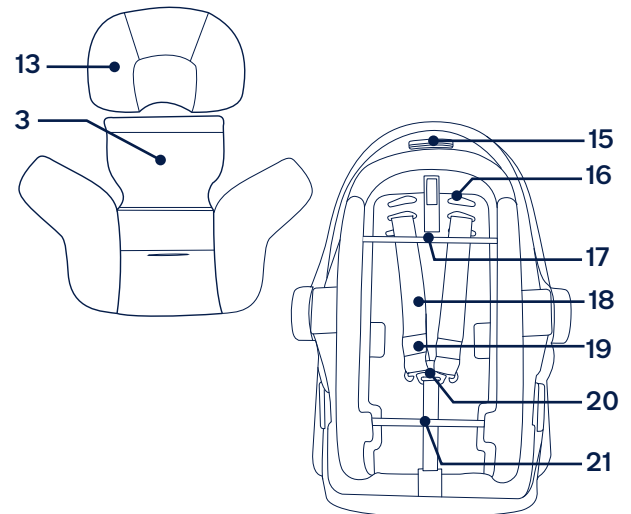
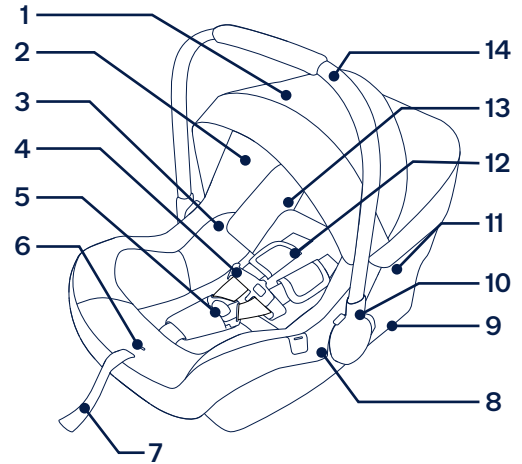

*only used with infant car seat post adapters

**only used with infant car seat ring adapters

Base Parts List

Make sure all parts are available before assembly. If any part is missing, please contact Nuna (see page 4 for information). No tools are required for assembly.

- | | | | |
|---|--------------------------------------|----|---------------------------------|
| 1 | Vehicle Belt Lock Off | 7 | Level Indicator |
| 2 | Rigid LATCH (lower attachments) | 8 | Carrier Release Button |
| 3 | Primary Rigid LATCH Release Button | 9 | Stability Leg Adjustment Button |
| 4 | Secondary Rigid LATCH Release Button | 10 | Stability Leg Indicator |
| 5 | Rigid LATCH Guides | 11 | Instruction Manual Storage |
| 6 | Stability Leg | 12 | Stability Leg Storage |
| | | 13 | Recline Adjustment |

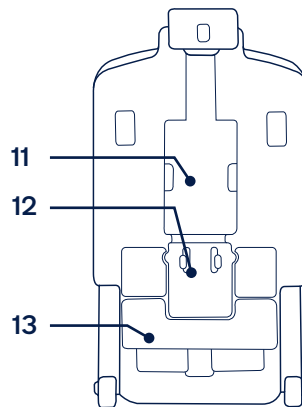
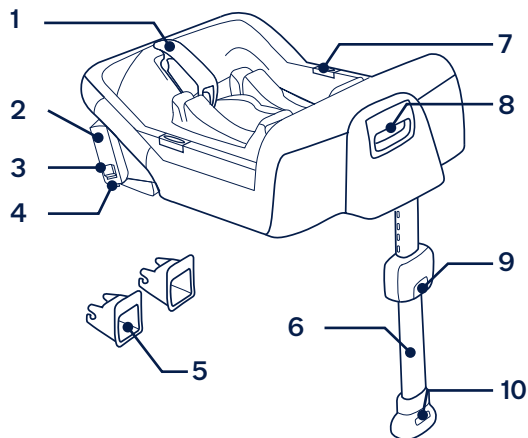

Product Overview

Canopy

- 1 - To attach the canopy, snap the canopy to the canopy mount on both sides. To open the canopy, pull the canopy toward the front of the seat, and to close the canopy, push it back.
- 2 - To remove the canopy, reverse step 1. Then unsnap the seat pad from the shell and lift fabric up.
- 3 - Press the canopy release button (1) and pull canopy through the fabric slot (2).

Repeat on opposite side.

Dream Drape™

Included on PIPA lite lx models.

- 4 - Unzip the zipper behind the front canopy bow.
- 5 - Pull the dream drape™ out of the compartment.

Attach the dream drape™ to the magnets on each corner to the front of the carrier.

Shoulder Harness Pads

- 6 - Shoulder harness pads are removable. Unfasten the hook and loop to remove the shoulder harness pads.

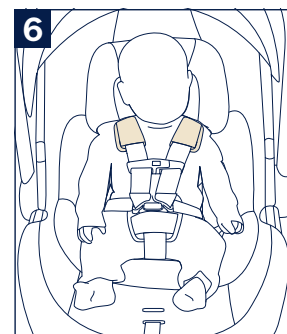
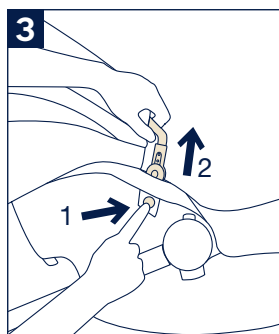
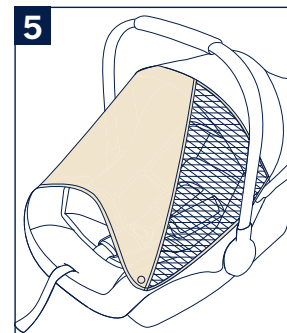
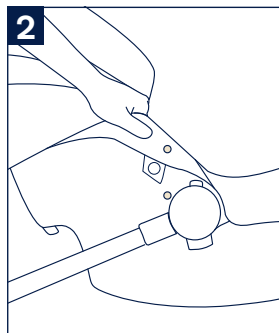
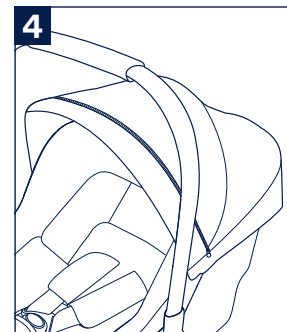
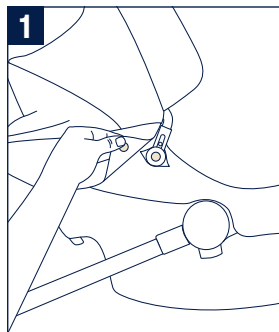

Crotch Pad

- 1 - Unbuckle the harness and locate the crotch pad strap.
- 2 - Keep the tab at the end of the crotch pad strap flat against the strap and then route the crotch pad strap through the front of the buckle.
- 3 - Pull the crotch pad off the buckle.

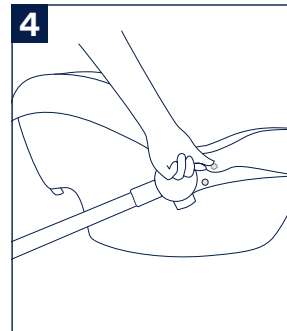
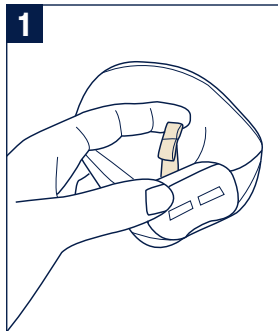

Seat Pad

- 4 - Open the snaps on both sides of the seat.
- 5 - Turn child restraint over and remove the harness straps from the splitter plate.
- 6 - Remove the seat pad.

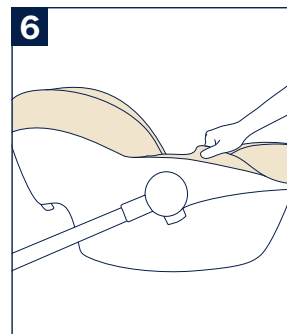
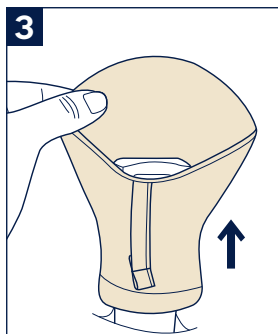
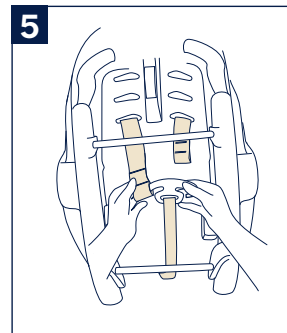
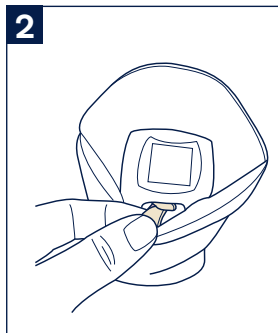

Head and Body Support

The head and body supports can be used as necessary, to provide a snug fit for small babies.

⚠ The head support straps cannot go through the same slots as the harness and should only be used in the top two harness slot positions.

- 1** - To remove the head support, unfasten the hook and loop ends behind the seat fabric.
- 2** - Then, pull the head support straps through the harness slots.
- 3** - To remove, the body support, unbuckle the harness and route the buckle and crotch belt through the bottom slot of the body support.
- 4** - The low birth weight pillow (located on the back of the body support) can be used in the body support for even smaller babies, but **MUST** be removed once a snug fit can be achieved without it, at approximately 11 lbs.
- 5** - To remove the low birth weight pillow, unfasten the hook and loop on the back of the body support and pull out the pillow.

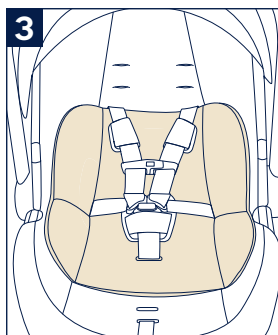
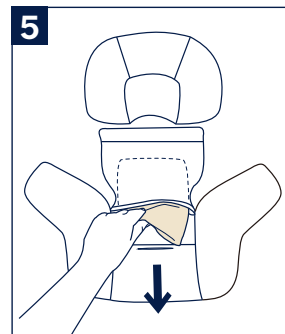
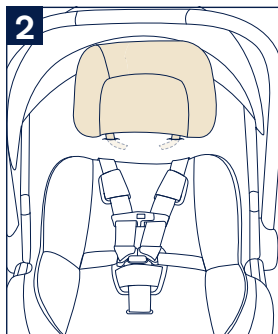
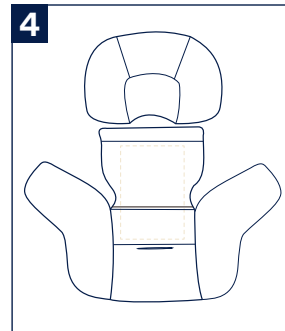

Shoulder Belts

- 1 - Tighten harness to fit snugly on child's shoulders. It is snug if you cannot pinch a fold in the strap.
- 2 - Harness straps must be at or just below shoulders.
- 3 - To adjust shoulder harness height, remove child and loosen harness by pressing the harness adjustment button (1) while pulling on the harness strap (2). The harness adjustment button is located inside the slot on the seat pad.
- 4 - Turn child restraint over and remove one harness loop from metal splitter plate.
- 5 - Pull loose ends of harness loop out through slots and place in correct slot.
- 6 - Repeat process for second shoulder harness strap and then re-attach harness to splitter plate.

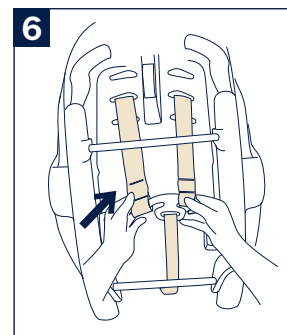
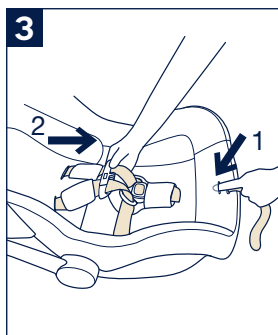
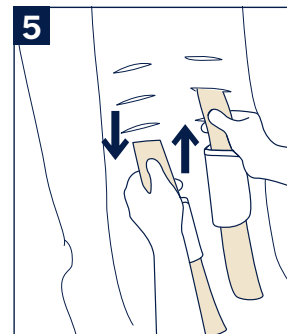
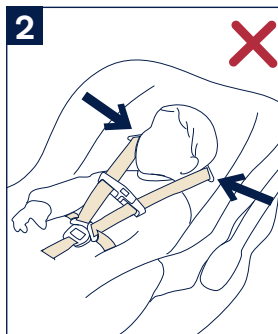
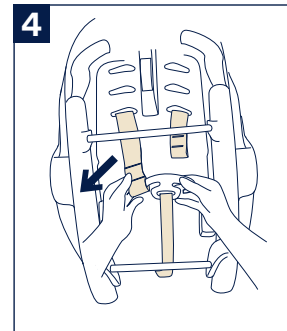
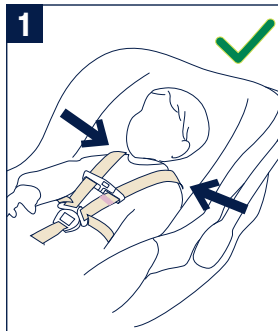

- 1 - For a smaller child, use the top shoulder harness loops (1) and for a larger child, use the bottom shoulder harness loops (2).
- 2 - **⚠ DO NOT** allow harness to pass over base attachment bars.
- 3 - Top of child's head is at least 1" below top of child restraint.

Handle Adjustment

- 4 - The infant carrier handle can be adjusted to 3 positions.
 - 5 - To adjust the handle position, squeeze handle adjustment buttons on both sides (1). Rotate handle until it clicks into any of the 3 positions. Handle can be used in vehicle in any locked position (2).
- ⚠** Be sure handle is locked in the carry position before lifting child restraint by handle. An unlocked handle could move unexpectedly, causing injury to child. Handle **MUST NOT** contact the vehicle interior (side of car or seat in front) when installed.

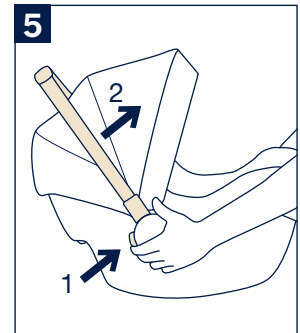
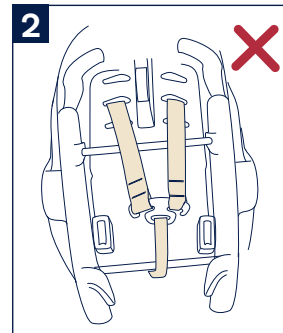
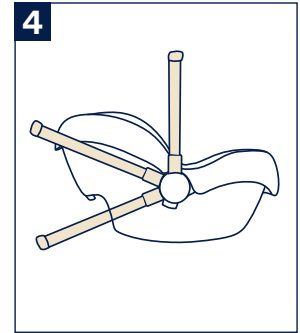
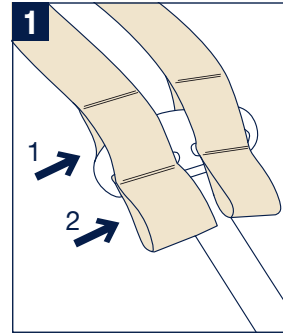

Product Use

Securing Child in Child Restraint

- 1 - Loosen harness by pressing the harness adjustment button (1) while pulling on the harness straps (2). The harness adjustment button is located inside the slot on the seat pad.
- 2 - Press chest clip button to release the buckles (1). Separate chest clip and spread harness straps apart (2).
- 3 - Place buckle tongues into both sides of the seat in the buckle holders to make placing baby more convenient.
- 4 - Place child in child restraint in seated position.
- 5 - The child should be seated against both the back and bottom of the seat with no gap behind the child. **DO NOT** allow child to slouch. Gently guide child's arms through harness loops.
- 6 - Insert buckle tongues into buckle and listen for clicks. Pull on buckle to verify it is latched.

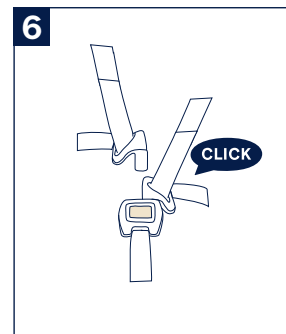
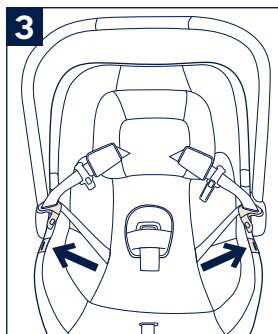
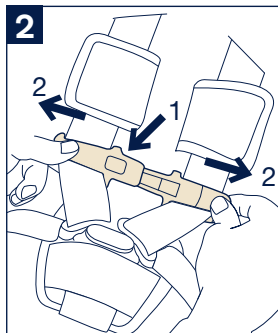
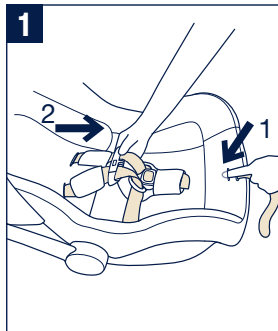

- 1 - Snap the chest clip together and temporarily slide towards buckle for tightening of harness.
- 2 - Tighten harness by pulling on the harness adjustment strap. Pull any excess harness webbing through the buckle towards the child's shoulder and pull on the harness adjustment strap. This may need to be repeated several times for proper fit.

Verify that the harness is snug around the child's waist and shoulders.

- 3 - Position the chest clip so it is at child's armpit level.

Check that Child is Secure

- Buckle is fastened.
- Harness straps are not twisted.
- Harness is snug – A snug harness cannot be pinched, and should not allow any slack.
- Chest clip is level with armpits.

- ⚠️** Harness straps must be at or just below child's shoulders to avoid injury. If harness slots need to be moved, see shoulder belts section.
- ⚠️** Make sure that nothing interferes with the harness. Make sure harness is snug around child and lays flat.
- ⚠️** If child is not secured properly, child could be ejected in a sudden stop or crash, resulting in serious injury or death.

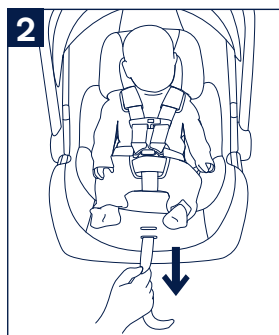
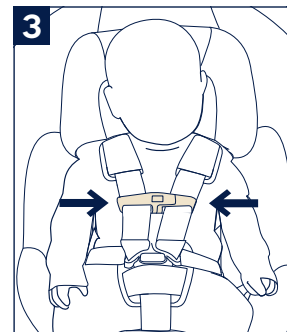
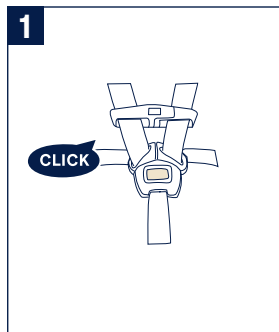

Installation

- 1 - **⚠️ WARNING** Serious injury or death can occur. The seat alone cannot be installed in the vehicle. It must be installed with the base.

Installation in an Aircraft

When used with the base, This Restraint is Certified for Use in Motor Vehicles and Aircraft.

Install the base on an aircraft by following the section **Installation Using Lap and Lap/Shoulder Belt** on page 36. It may be necessary to shorten the lap belt by twisting it, to achieve a proper installation.

Installation on a Stroller

This infant carrier can attach to Nuna strollers as well as other brands of strollers using adapters. Please visit nuna.eu for more information.

Base Installation Using Rigid LATCH (Lower Attachments)

- 2 - Place vehicle in park and on level ground.
- 3 - Position base in a forward facing vehicle seat. Adjust base so bubble touches line.
- 4 - If necessary, use recline adjustment to position bubble in level indicator to achieve correct angle for installation. Recline adjustment locks into position.
- 5 - To release recline adjustment, press down on lock button located under base.
- 6 - If necessary, install rigid LATCH guides on vehicle  LATCH lower anchor bars.

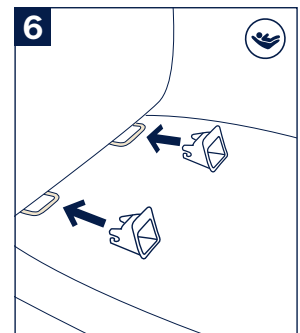
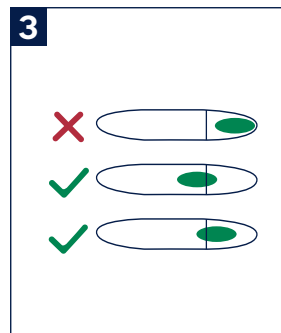
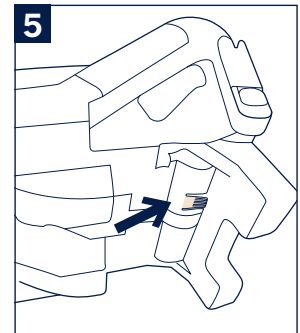
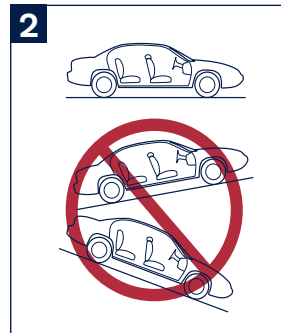
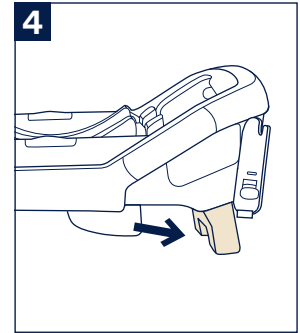
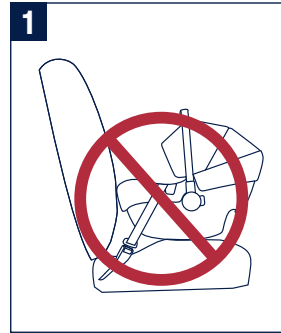

- 1 - Rotate rigid LATCH (lower attachments) down.
 - 2 - Hook rigid LATCH onto vehicle LATCH lower anchor bars.
 - 3 - Confirm proper installation by pulling on the base **AND** also seeing that green is indicated on the connectors.
- ⚠** The rigid LATCH (lower attachments) must be attached and locked onto the vehicle anchor bars.

Additional stability can be achieved with the base by using the stability leg. For instructions on using the stability leg see stability leg section.

Check the installation

- Base should not move side to side or forward more than 1" at belt path.
- Bubble must be touching line. Use recline adjustment, if needed, to position bubble.

It is acceptable to install with both LATCH (lower attachments) and the vehicle belt.

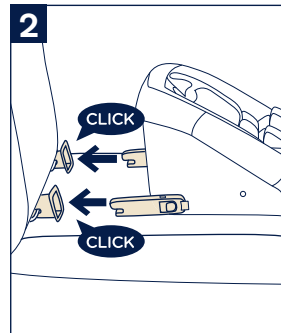
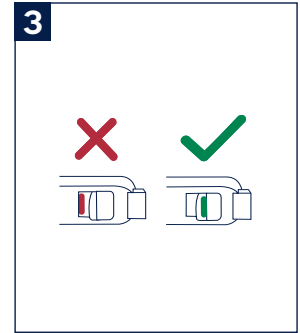
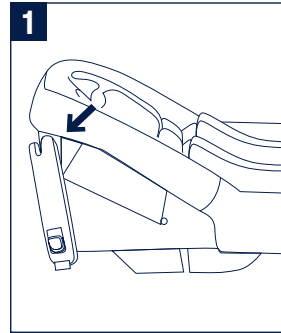

Attaching Child Restraint to Base

1 - After child is properly secured in child restraint, press child restraint on base and listen for a click. Pull on child restraint to verify installation.

⚠ DO NOT allow child restraint or handle to contact the vehicle interior (side of car door or seat in front) when installed on base.

2 - To release the child restraint, squeeze the carrier release button **(1)** located on the base and then pull the child restraint up **(2)**.

3 - To remove the base, first push the base toward the vehicle seat with a light force.

4 - As you push the base toward the vehicle seat, squeeze the secondary **(1)** and primary rigid LATCH release buttons **(2)**. For ease of release, push the secondary button first, then the primary button.

5 - Then pull the base off of the bars.

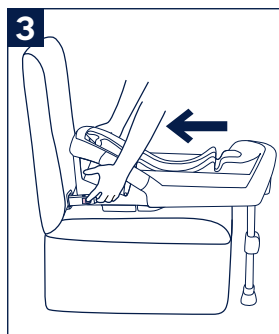
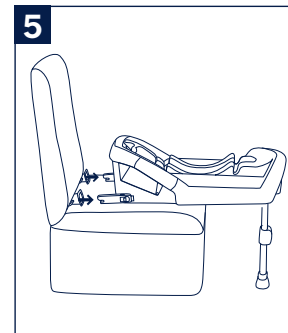
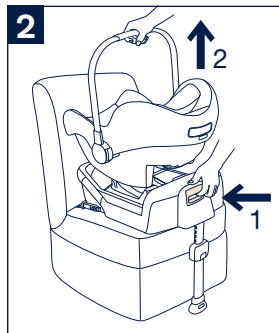
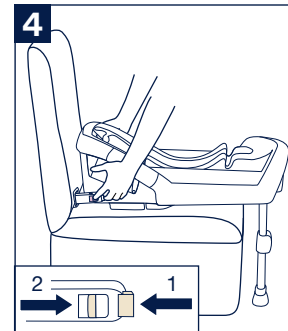
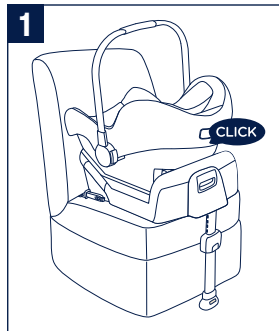

Installation Using Lap and Lap/Shoulder Belt

- 1 - Place vehicle in park and on level ground.
- 2 - Position base in a forward facing vehicle seat. Adjust base so bubble touches line.
- 3 - If necessary, use recline adjustment to position bubble in level indicator to achieve correct angle for installation. Recline adjustment locks into position.
- 4 - To release recline adjustment, press down on lock button located under base.
- 5 - Open the vehicle belt lock off by lifting up.
- 6 - Route the vehicle belt through the opening in the base labeled "belt here" and under the vehicle belt lock off.

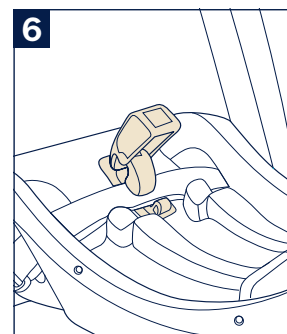
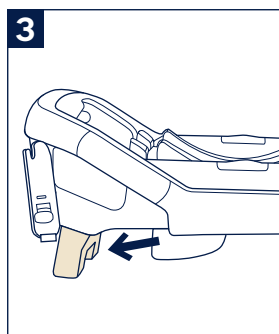
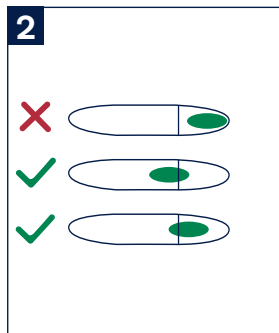
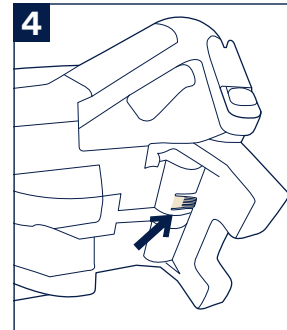
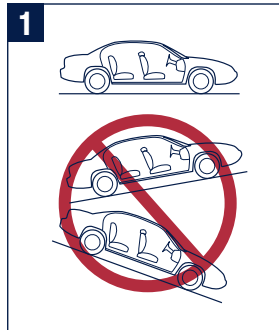

- 1 - Buckle the vehicle belt. Both the shoulder **AND** lap belt must be under the vehicle belt lock off and belts must lay flat.
- 2 - While pressing the base into the vehicle seat (1), tighten the vehicle belt by pulling straight along the belt path (2).
- 3 - While the shoulder belt is tight, hook the bottom of the vehicle belt lock off (1) and press to close (2).

If vehicle only has a lap belt, then put lap belt under vehicle belt lock off.

Additional stability can be achieved with the base by using the stability leg. For instructions on using the stability leg see stability leg section.

Check the installation

- Belts must be tight.
- Base should not move side to side more than 1" at belt path.
- Bubble must be touching line.
- Belts and buckles must not interfere with attachment of child restraint to base.
- Vehicle belts must lay flat under vehicle belt lock off.

It is acceptable to install with both LATCH (lower attachments) and the vehicle belt.

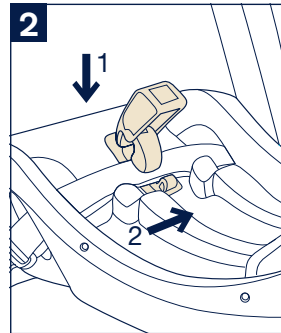
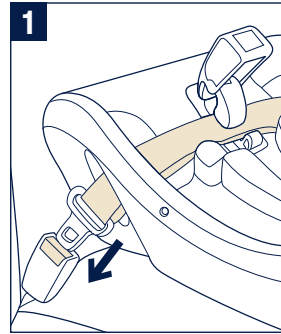

1 - After child is properly secured in child restraint, press child restraint on base and listen for a click. Pull on child restraint to verify installation.

⚠ DO NOT allow child restraint or handle to contact the vehicle interior (side of car door or seat in front) when installed on base.

2 - To release the child restraint, squeeze the carrier release button **(1)** located on the base and then pull the child restraint up **(2)**.

3 - To remove the base, lift up on the vehicle belt lock off.

4 - Unbuckle the vehicle belt and un-route the shoulder and lap belt from the base.

Then remove the base.

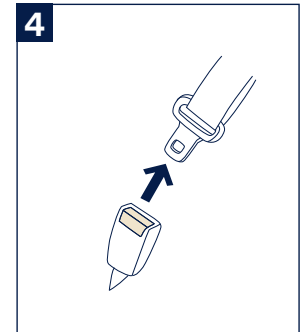
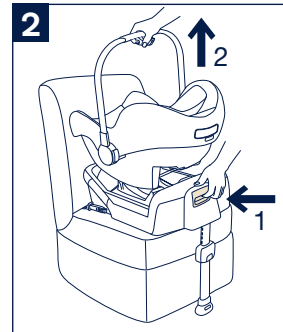
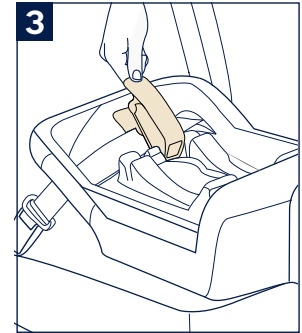
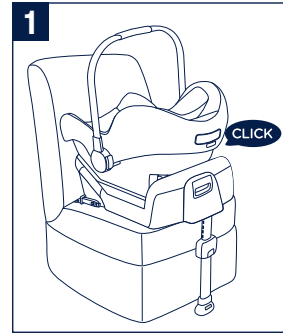

Stability Leg

Refer to vehicle owner's manual to determine if stability leg can be used over a vehicle storage compartment.

- 1 - Unfold the stability leg from the stability leg storage.
- 2 - After correctly installing the base on the vehicle seat, press the stability leg adjustment button to extend the stability leg to the floor.
- 3 - Stability leg should make firm contact with the vehicle floor.
- 4 - Indicators should show green.

⚠ When the stability leg indicator shows red this means the stability leg is in the wrong position. Make sure the stability leg is secure and makes firm contact with the vehicle floor. The stability leg indicator shows green when it is properly contacting the floor of the vehicle.

- 5 - **DO NOT** use if stability leg lifts base off seat.

⚠ **DO NOT** use stability leg to recline the base. The recline adjustment feature is meant to recline the base.

Always store stability leg when not in use.

This seat is safe to use with stability leg in use or stored for both rigid LATCH or vehicle belt installation.

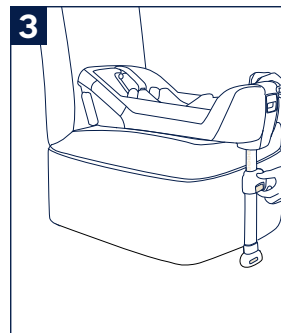
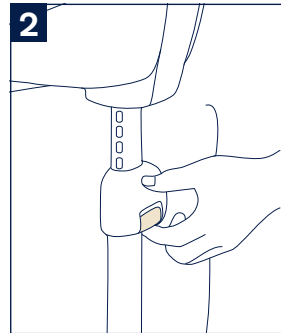
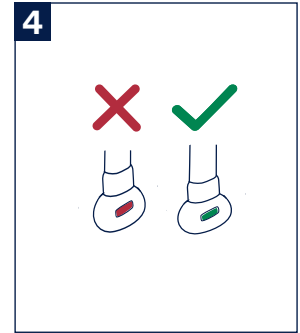
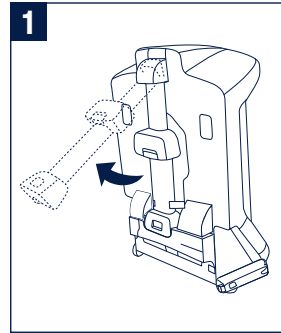

Accessories

⚠ Not all accessories are included on some models.

PIPA series organic cotton insert

1 - The PIPA lite series include an additional organic cotton insert with the same features as the on-product head and body support. See the Head and Body Support section for on-product removal and installation.

The head and body supports can be used as necessary, to provide a snug fit for small babies.

⚠ The head support straps cannot go through the same slots as the harness and should only be used in the top two harness slot positions.

PIPA series adapters

The PIPA lite series can attach to Nuna strollers using adapters. Instructions are included with the adapters, which are sold separately.

2 - Infant Car Seat Post Adapters

3 - Infant Car Seat Ring Adapter

This infant carrier can also attach to other brands of strollers using adapters. Please visit nuna.eu for more information.

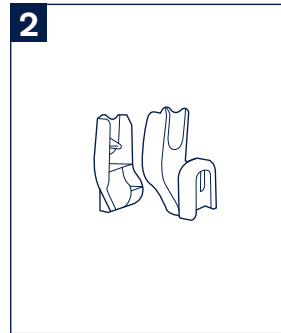
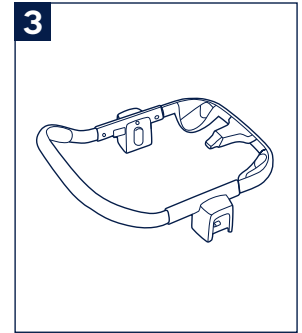
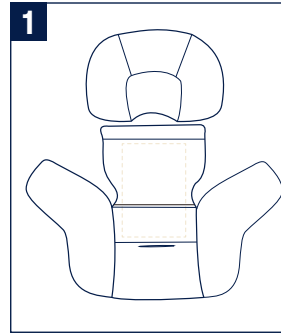

Cleaning and Maintenance

Refer to the care label attached to the soft goods for washing and drying instructions.

DO NOT attempt to remove the foam under the seat pad.

Use only mild detergent, water and a soft cloth to clean the infant carrier shell, handle and harness straps. Air dry.

To clean the buckle: rinse using warm water. **DO NOT** use any soaps, solvents or lubricants. Using anything other than water can cause the buckle to malfunction. Air dry.

Remove the infant carrier from the vehicle seat if not in use for a long period of time. Put the infant carrier in a cool, dry place and somewhere your child can not access it.

It is normal for fabric to color from sunlight and to show wear and tear after a long period of use, even when used normally.

Check regularly if everything functions properly. If any parts are torn, broken, or missing, stop using this product.



Nuna Baby Essentials, Inc.

70 Thousand Oaks Blvd. | Morgantown, PA 19543

1.855.NUNA.USA | Nuna.eu